

AI-518/AI-518P

ARTIFICIAL INTELLIGENCE INDUSTRIAL CONTROLLER

Operation Instruction

Ver. 8.1

*(Applicable for accurate controls of
Temperature, Pressure, Flow, Level and Humidity etc.)*

CONTENTS

1. SUMMARY	1
1.1 MAIN FEATURES	1
1.2 ORDERING CODE DEFINITION	1
1.3 MODULES	2
1.3.1 Slots of modules	2
1.3.2 Commonly used modules:	2
1.3.3 Installation and replacement of modules	2
1.3.4 Electric isolation of the modules	2
1.3.5 Further descriptions about module applications	2
1.4 TECHNICAL SPECIFICATION	3
1.5 REAR TERMINAL LAYOUT AND WIRING	4
2. DISPLAYS AND OPERATIONS.....	5
2.1 FRONT PANEL DESCRIPTION	5
2.2 PARAMETER SETTING FLOW CHART	5
2.3 OPERATION DESCRIPTION	6
2.3.1 Parameter Setting	6
2.3.2 Set Value Setting	6
2.3.3 Auto Tuning	6
3. PARAMETERS AND SETTINGS.....	7
3.1 PARAMETER LOCK (LOC) AND FIELD PARAMETERS	7
3.2 THE PARAMETER TABLE	7
3.3 ADDITIONAL REMARKS OF SPECIAL FUNCTIONS	11
3.3.1 Single-phase phase-shift trigger output	11
3.3.2 Alarm blocking at the beginning of power on	11
3.3.3 Setpoints switch	11
3.3.4 Communication function	11
3.3.5 Temperature re-transmitter / Program generator / Manual current output	12
4. FURTHER DESCRIPTION FOR THE OPERATION OF AI-518P SERIES INSTRUMENT	12
4.1 CONCEPTS AND FUNCTIONS PROGRAM	12
StEP:	12
StEP time:	12
Running time:	12
Jump:	12
Run/Hold:	12
Stop:	12
Power cut/resume event handling:	12
PV startup and PV preparation function (rdy function) :	12
Curve fitting:	12
5. PROGRAMMING AND OPERATION (FOR AI-518P ONLY)	13
5.1 RAMP MODE(PAF : B=0)	13
5.2 SOAK MODE(PAF : B=1)	13
Time setting	13
Program arrangement of multi-curve operation	14

1. SUMMARY

1.1 Main Features

- Use digital calibration technology for input measurement with input measurement accuracy F.S.0.25%, Support standard thermocouples and RTDs, maximum resolution is 0.01°C
- Use advanced artificial intelligent control algorithm, no overshoot and with the function of auto tuning (AT) and self-adaptation.
- Use advanced modular structure, conveniently providing plentiful output options, able to satisfy the requirements of various applications, make quick delivery and convenience the maintenance of the instrument.
- Friendly and customized operating interface leads to quick and easy to operate. Parameter can be promoted to immediate operator access in Field Parameter Table or password protected in Full Parameter Table.
- With worldwide power supply of 100-240VAC or 24VDC and various installation dimensions for users to choose.
- ISO9001 and CE certified, achieving world class level of quality, anti-interference ability and safety.

POINTS FOR ATTENTION

- This manual is AI-518/AI-518P ARTIFICIAL INTELLIGENCE INDUSTRIAL CONTROLLER Version 8.1. Certain functions in this manual are probably not applicable for the instrument of other version. When the power is on, instrument model and software version will be displayed. User should pay attention to the difference between different versions when using the instrument. Please read this manual carefully in order to use the instrument correctly and make it to its full use.
- Please correctly set parameters according to input / output type and function. Only correctly wired instruments with parameters correctly set can be put into use.

1.2 Ordering Code Definition

Advanced modularized hardware design is utilized for AI series instruments. There are maximum five module slots: multi-function input/output (MIO), main output (OUTP), alarm (ALM), auxiliary output (AUX) and communication (COMM). The modules can be purchased together or individual, and can be assembled freely. The input type can be set to thermocouple, RTD, or linear current/voltage.

The ordering code of AI-518/AI-518P (V8.1) series instrument is made up of 9 parts. For example:

AI-518 A N X3 L5 N S4 - 24VDC - (F2)
① ② ③ ④ ⑤ ⑥ ⑦ ⑧ ⑨

It shows that the model of this instrument is AI-518, front panel dimension is A size(96×96mm), no module is installed in MIO slot, X3 linear current output module is installed in OUTP (main output), ALM (alarm) is L5 (dual relay contact output module), no module is installed in AUX (auxiliary output), S4 (RS485 communication interface module) is installed at COMM, and the power supply of the instrument is 24VDC, an extended input type (F2 radiation type pyrometer) is available

The following is the meanings of the 9 parts:

- ① Shows the model of the instrument
AI-518 Economical type instrument with measurement accuracy 0.25%F.S. It adopts artificial intelligent control technology, and has the functions of control, alarm, retransmission and communication.
AI-518P Base on AI-518 added 30 segments programmable functions.
- ② Shows the front panel dimension
A(A2) Front panel 96×96mm(width×height), cut out 92×92mm, depth behind mounting surface 100mm. A2 has a light bar with 25 segments and 4 levels of luminosity.
B Front panel 160×80mm(width×height), cut out 152×76mm, depth behind mounting surface 100mm.
C(C3) Front panel 80×160mm(width×height), cut out 76×152mm, depth behind mounting surface 100mm. C3 has an additional light bar with 50 segments and 2 levels of luminosity.
D Front panel 72×72mm(width×height), cut out 68×68mm, depth behind mounting surface 95mm
D2 Front panel 48×48mm(width×height), cut out 45×45mm, depth behind mounting surface 95mm`
E Front panel 48×96mm(width×height), cut out 45×92mm, depth behind mounting surface 100mm
F Front panel 96×48mm(width×height), cut out 92×45mm, depth behind mounting surface 100mm
- ③ Shows the module type of multiple functions I/O (MIO). Selectable modules are I2, I4, K3 and V, etc. N means no module been installed.
- ④ Shows the module type of main output (OUTP). Selectable modules are L1,L2,L4,W1,W2,G,K1,K3,K5,K6,X3,X5 etc.
- ⑤ Shows the module type of alarm (ALM). Selectable modules are L1, L2, L4, L5, W1, W2, G, etc.
- ⑥ Shows the module type of auxiliary output (AUX). Selectable modules are L1, L2, L4, L5, W1, W2, G, K1, X3, X5, etc.
- ⑦ Shows the module type of communication (COMM). Selectable modules are S, S4, V, etc.
- ⑧ Shows the power supply of the instrument. If left blank, the power of the instrument is 100~240VAC. Added "24VDC" means the power supply of 20~32V DC or AC power
- ⑨ Shows the optional extended graduation spec (If none, leave it blank). AI-518 series instruments support many input types including popular thermocouples, RTDs, linear voltage, current and resistance inputs. If needed, an additional specification not mentioned in input type selection (InP) table can be extended.

Note 1: The instrument applies the technology of automatic zero and digital calibration, and is free of maintenance. If the error exceeds certain range, generally, cleaning and drying the inside of the instrument can fix it. If not, send the instrument back to the factory to examine and repair.

1.3 Modules

1.3.1 Slots of modules

AI-518/518P series instruments have five slots for modules to be installed (D dimension instruments have 3 slots: OOTP, AUX and COMM/AL1; D2 dimension instruments have 2 slots: OOTP and COMM/AUX). By installing different modules, the controller can meet the requirements of different functions and output types.

- **Multiple function Input / Output (MIO):**

Can input signal from 2-wire transmitter or 4-20mA signal by installing I4 (current input) module and I4 module can provide 24VDC to transmitter. If a I2 (on-off signal input) module is installed, the instrument can switch between set points SV1 and SV2 by an external switch. Cooperating with OOTP and installing a K3 module can realize three-phase thyristor zero cross triggering output.

- **Main output (OOTP):**

Commonly used as control output such as on-off control, standard PID control, and AI PID control. It can be used as retransmission output of process value (PV) or set point (SV). Installing L1 or L4 modular can realize relay contact output; installing X3 or X5 module can realize 0-20mA/4-20mA/0-10mA linear current output; installing G module can realize SSR voltage output; installing W1 or W2 module can implement TRIAC no contact switch output.

- **Alarm (ALM):**

Commonly used as alarm output. Support 1 normally open + normally close relay output (AL1) by installing L1 or L2 module or 2 normally open relay outputs (AL1+AL2) by installing L5 module.

- **Auxiliary output (AUX):** In a heating/refrigerating dual output system, module X3, X5, L1, L4, G, W1, W2 can be installed for the second control output. It can also output alarm by installing L1, L2 or L5 module, or be used for communicating with computer by installing R module (RS232C interface).

- **Communication Interface (COMM):** Module S or S4 can be installed in for communicating with computer (RS485 communication interface), and it can also be used as power supply for external sensor when equipped with a voltage output module (except for front panel D2 size).

1.3.2 Commonly used modules:

N No module installed (or null)

L1/L2 Normally open + normally close relay output module (small volume, capacity: 30VDC/1A, 250VAC/1A, suitable for alarm, L1 modules is 2A)

L4 Large capacity normally open relay output module (large volume, Capacity: 30VDC/2A, 250VAC/2A)

L5 Dual normally open relay output module (Capacity: 30VDC/2A, 250VAC/2A)

W1/W2 TRIAC no contact normally open (W2 is normally close) discrete output module (Capacity: 100-240VAC/0.2A)

G SSR voltage output module (DC12V/30mA)

G5 Dual SSR voltage driver (DC12V/30mA)

K1 Single-phase thyristor zero crossing trigger output module (can trigger one loop of a TRIAC or a pair of inverse parallel SCR with current of 5-500A)

K3 Three-phase thyristor zero crossing trigger output module (can trigger 3-phase circuit; each loop can trigger TRIAC or a pair of inverse parallel SCR with current of 5-500A)

K5/K6 Single-phase 220VAC/380VAC thyristor phase-shift trigger output module (can trigger one loop of TRIAC or a pair of inverse parallel SCR with current of 5-500A), only 50Hz power

X3/X5 Linear current output module (continuous 0-22mA output, selectable in the range of 0-10mA, 4-20mA etc.). X5 is equipped with photoelectric isolated power supply.

S/S4 RS485 communication interface module. S4 is equipped with photoelectric isolated power supply.

R RS232 communication interface module.

I2 Switch / frequency signal input interface for inputting external switch or frequency signal, has a 12VDC power supply for external transducer.

I4 4-20mA/0-20mA analogue input interface, has a 24VDC/24mA power supply for a transmitter.

V24/V12/V10/V5

Isolated 24V/12V/10V/5V DC voltage output with maximum current of 50mA, can supply power for transmitter.

1.3.3 Installation and replacement of modules

Before the instrument delivery, module installation is done on request, with corresponding parameter set correctly. Users can replace or install modules by themselves when needed. When replacing a module, you should pull the controller out of the housing at first, insert a small flat-tip screwdriver into the opening between the original module and the slot on motherboard to remove the old module, and then install a new module. Changing module type needs to modify the corresponding parameters.

1.3.4 Electric isolation of the modules

There are a group of 24V and a group 12V power supply built in the instrument and isolated to the main circuit. The 24V power commonly supplies voltage output module, such as V24/V12/V10/V5, I2 and I4. The 12V power is commonly supplies output or communication module. Generally, the relay contact output and TRIAC no contact discrete output are self insulated from the other circuit, no matter whether other modules are installed or not. SSR output voltage does not need to be insulated from input circuit, because SSR itself has isolation function. Therefore, only the electric isolation between the communication interface and the current output should be considered. Those modules, for example, S (RS485 communication interface), R (RS232 communication interface) and X3 (linear current output), all need the 12V power supply. If more than one of the above modules are installed, in order to be electric isolated, only one of them can be module without electric isolation, the other modules should be S4 or X5, which has its own isolated power supply. For example, if an X3 module is installed in OOTP (main output) slot, for isolate purpose, COMM slot should be install S4 or X5.

1.3.5 Further descriptions about module applications

- **Voltage output module:** The voltage output modules like V24, V12, V10 or V5 are often used for supplying power for external transducer or feedback resistance of transmitter. These modules can be installed in any slot. To standardize the wiring, it is recommended to be installed in the first idle slot in the order of MIO, AUX, and

COMM.

- **No contact switch module:** W1 and W2 are new types of no contact switch module which apply the advanced technology of "burn proof" and zero crossing conduction. It can replace the relay contact switch. Compared to the relay contact output module, W1 and W2 have longer life and lower interference. They can be largely lower the interference spark of the equipment, and greatly improve the stability and reliability of the system. Protection elements are series wound to the output terminals, so it can control continuous current up to 0.2A with maximum allowed instantaneous current 2A. Since the driver element is TRIAC, it is suitable for controlling 100-240VAC (not for DC power) with contactor which current below 80A. For the current larger than 80A, an intermediate relay is needed.
- **Relay switch module:** The relay modules are widely used in industrial control. However, they are the only modules with life time limit and volume limit and have much electromagnetic interference. It is important to choose a suitable relay module. To control equipments with 100~220VAC supply, such as contactor and electromagnetic valve, W1 module is recommended. To control DC or AC above 50VAC, users can only use relay module. L2 module is small, and both its normal open and normal close terminals have the function of spark absorption, but the capacity is small. It is suitable for alarm output. L1 and L5 have bigger volume and capacity. In the 48mm dimension instrument (for example, D4, E, F and E5), only one of L1 or L5 can be installed. L5 has dual output, can be used to support two loops of alarm, for example, AL1+AL2. If you don't like mechanical switch, you can choose G5 (dual SSR voltage driver) and connect with external SSR instead.

1.4 TECHNICAL SPECIFICATION

- **Input type: (Either of below specifications can be used selectively in the one instrument)**
Thermocouple: K, S, R, E, J, N, T, B, WRe3-WRe25, WRe5-WRe26.
Resistance temperature detector: Cu50, Pt100
Linear voltage: 0~5V, 1~5V, 0~1V, 0~100mV, 0~20mV, 0~500mV etc.
Linear current (external precise shunt resist needed): 0~10mA, 0~20mA, 4~20mA, etc.
Extended input (install I4 module in MIO) : 0~20mA, 4~20mA or two line transmitter.
Optional: apart from the above-mentioned Input type, an additional type can be provided upon request. (Graduation index is needed)
- **Instrument Input range**
K(-50~1300°C), S(-50~1700°C), R(-50~1700°C), E(0~800°C), J(0~1000°C), N(0~1300°C), T(-200~+350°C), B(200~1800°C)
Cu50(-50~+150°C), Pt100(-200~+600°C)
Linear Input: -9990~30000 defined by user
- **Measurement accuracy** : 0.25%FS ± 1 measurement unit
- **Resolution** : 0.1°C for K, E, T, N, J, Cu50, Pt100; 1°C for S,R
- **Temperature shift** : ≤0.015%FS /°C (typical value is 80ppm/°C)
- **Sampling period** : read A/D converter 8 times per second
- **Response time** : ≤0.5s (when digital filter parameter FILt=0)
- **Alarm function** : High limit, low limit, deviation high limit and deviation low limit; providing the function of alarm blocking at the beginning of power on.
- **Control period** : 0.24~300.0 seconds selectable, and it should be integer times of 0.5 second.
- **Control mode:**
On-off control mode (dead band adjustable)
Standard PID with auto tuning
AI PID with auto tuning, adopting artificial intelligence algorithm.
- **Output mode (modularized)**
Relay output (NO+NC): 250VAC/2A, 30VDC/2A, 250VAC/1A and 30VDC/1A
TRIAC no contact discrete output (NO or NC): 100~240VAC/0.2A (continuous), 2A (20mS instantaneous, repeat period ≥5s)
SSR Voltage output: 12VDC/30mA (used to drive SSR).
Thyristor zero crossing trigger output: Can trigger TRIAC of 5~500A, a pair of inverse paralleled SCRs or SCR power module.
Linear current output: 0~20mA, 4~20mA can scaling by user. (Output voltage : X3 ≥10.5V; X5 ≥7V maximum load resistor 500ohm, output precision 0.2%FS)
- **Electromagnetic compatibility (EMC):** ±4KV/5KHz according to IEC61000-4-4; 4KV according to IEC61000-4-5.
- **Isolation withstanding voltage** : Between power, relay contact or signal terminals ≥2300VDC; between isolated electroweak terminals ≥600V
- **Power supply** : 100~240VAC, -15%, +10% / 50-60Hz; 120~240VDC; or 24VDC/AC, -15%, +10%.
- **Power consumption:** ≤5W
- **Operating Ambient** : Temperature 0~60°C; humidity ≤90%RH
- **Front panel dimension:** 96×96mm, 160×80mm, 80×160mm, 48×96mm, 96×48mm, 48×48mm, 72×72mm
- **Panel cutout dimension:** 92×92mm, 152×76mm, 76×152mm, 45×92mm, 92×45mm, 45×45mm, 68×68mm
- **Depth behind mounting surface:** ≤100mm

1.5 Rear Terminal Layout and Wiring

Wiring graph of instruments

Note 1: For linear voltage input, if the range is below 500mV, connect to terminals 19 and 18. 0~5V or 1~5V signal can be inputted from terminals 17 and 18.

Note 2: 4~20mA linear current signal can change to 1~5V voltage signal by connecting a 250 ohm resistor, and then be inputted from terminals 17 and 18. If I4 module is installed in MIO slot, 4~20mA signal can be inputted from terminals 14+ and 15-, and 2-wire transmitter can be inputted from terminals 16+ and 14-.

Note 3: The compensation wires for different kinds of thermocouple are different, and should be directly connect to the terminals. When the internal auto compensation mode is used, connecting the common wire between the compensation wire and the terminals will cause measurement error.

Note 4: When main output selected linear current or SSR voltage, output form terminal 13+, 11-,

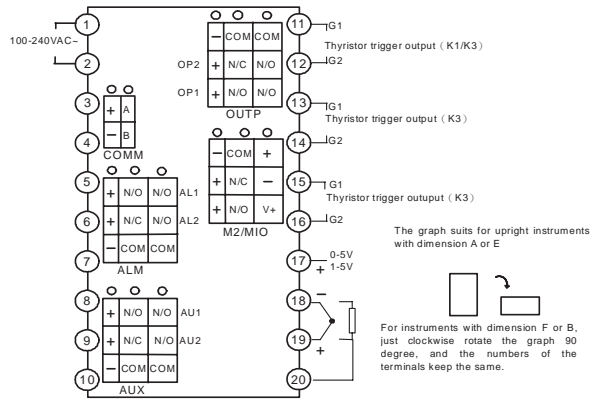

Wiring graph of D dimension instruments (72x72mm)

Note 1: Linear voltage signal of range below 500mV should be inputted from terminals 13 and 12, and signal of 0~5V and 1~5V should be inputted from terminals 11 and 12.

Note 2: 4~20mA linear current signal can be converted to 1~5V voltage signal by connecting a 250 ohm resistor and inputted from terminals 11 and 12.

Note 3: S or S4 module can be installed in COMM slot for communication. If relay, TRIAC no contact switch, or SSR drive voltage output module is installed in COMM, it can be used as alarm output. If I2 module is installed in COMM and parameter "bAud" is set to 1, SV1 and SV2 can be switching by connecting a switch between terminals 3 and 4.

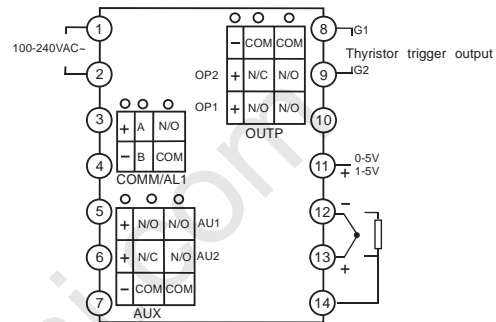

Wiring graph of instruments with D2 dimension as below:

Note 1: D4 dimension instruments don't support 0~5V or 1~5V linear voltage input. However, 0~5V or 1~5V signal can be converted to 0~500mV or 100~500mV by connecting external precise resistors, 4~20mA can be converted to 100~500mV by connecting a 250ohm resistor, then be inputted from terminals 9 and 8.

Note 2: For COMM/AUX slot, if S or S4 communication module is installed, it can be used for communication; if L2 module is installed in, parameter set bAud = 0, it can be used for AU1 or AU2 alarm output; if set parameter bAud = 2, it can be used for AU1 or AL1 alarm output. If L1, L2, L4, G, K1, W1 or W2 is installed, it can be the auxiliary output in bidirectional (heating/refrigerating) control (Auxiliary output doesn't support analog current output); if I2 is installed and bAud = 1, then it can input on-off signal to switch SP1 and SP2 (AI-518) or switching the program status RUN / Stop (AI-518P) by connecting a switch between terminals number 3 and 5.

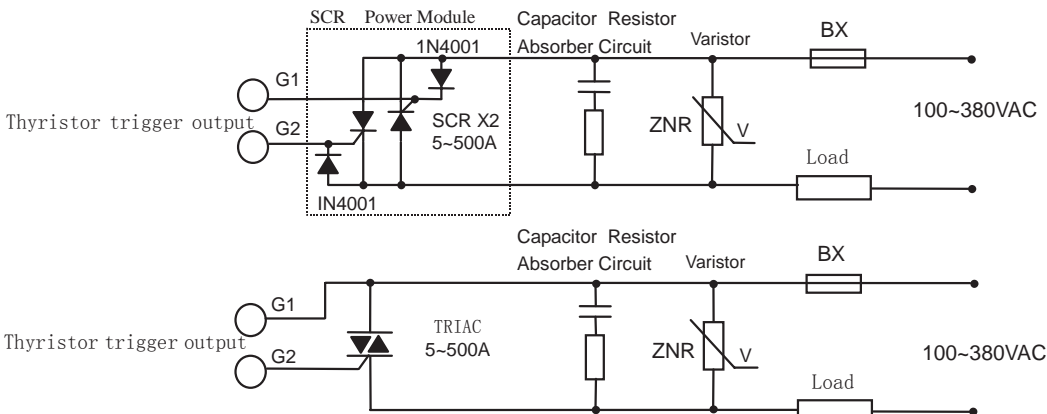
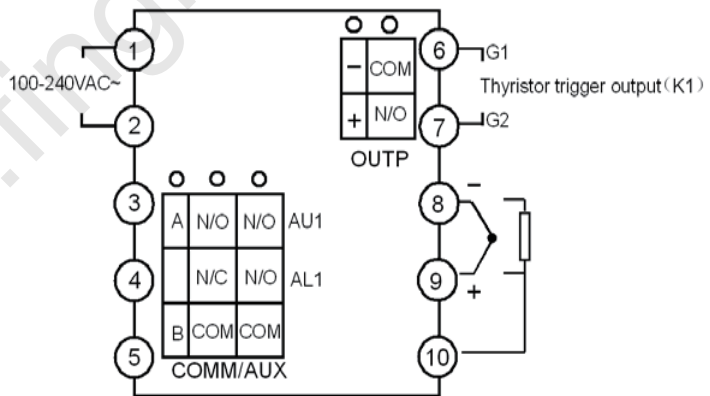

Note 1: According to the voltage and current of load, choose a suitable varistor to protect the thyristor. A resistor-capacitor circuit (RC circuit) is needed for inductance load or phase-shift trigger output.

Note 2: SCR power module is recommended. A power module includes two SCRs, is similar to the above dashed square.

Note 3: K5 and K6 TRIAC trigger module only support 220~380VAC and 50Hz power.

2. DISPLAYS AND OPERATIONS

2.1 Front Panel Description

- ① Upper display window: Displays PV, parameter code, etc.
- ② Lower display window: Displays SV, parameter value, or alarm message
- ③ Setup key: For accessing parameter table and conforming parameter modification.
- ④ Data shift key, start auto tuning
- ⑤ Data decrease key, and also run switch
- ⑥ Data increase key, and also stop key
- ⑦ LED indicator: "MAN" led is non-applicable for AI-518 series. "RUN" led on, it mean AI-518P running program. MIO, OP1, OP2, AL1, AL2, AU1 and AU2 indicate I/O operation of the corresponding module. For example, when COMM led is lighting means that the instrument is communicating with computer.

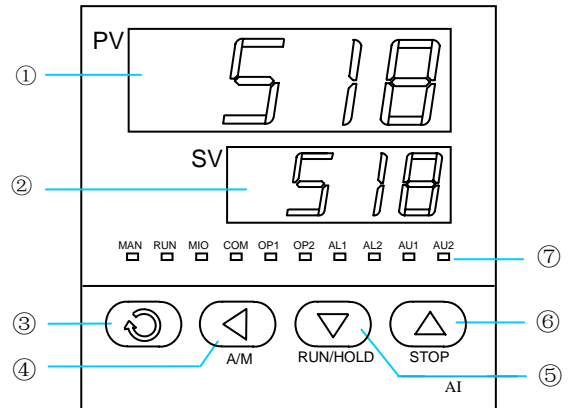

Basic display status : When power on, the upper display window of the instrument shows the process value (PV), and the lower window shows the set point (SV). This status is called basic display status. Symbol description was shown as following table:

Symbol	Description
orAL	Input specification setting is incorrect Or Input wiring is disconnected/ thermocouple problem Or Short circuited
HIAL	High limit alarm
LoAL	Low limit alarm
HdAL	Deviation high alarm
LdAL	Deviation low alarm
EErr	IC Software error
8888	IC Software error

Note 1: The alarm message can turn off by setting parameter AdIS to oFF.

Note 2: When occur orAL alarm, instrument will cut the output in short period.





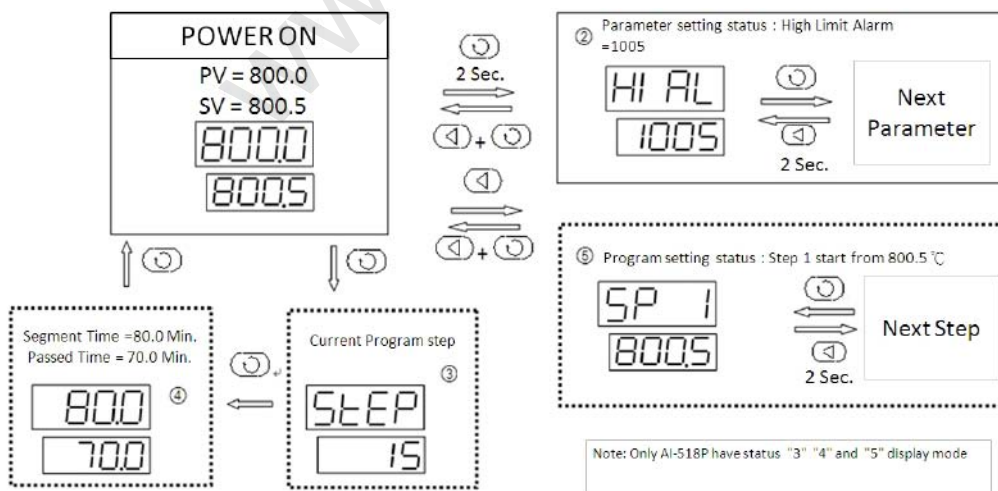



Note 3: For AI-518P, "StoP", "HoLd" and "rdy" which mean the status in stop, hold and ready.



2.2 Parameter Setting Flow Chart











2.3 Operation Description

2.3.1 Parameter Setting

In basic display status, press  and hold for about 2 seconds can access Field Parameter Table. Press  can go to the next parameter; press ,  or  can modify a parameter. Press and hold  can return to the previous parameter. Press  (don't release) and then press  key simultaneously can escape from the parameter table. The instrument will escape automatically from the parameter table if no key is pressed within 25 seconds, and the change of the last parameter will not be saved.

In Field Parameter Table,  till the last field parameter Loc appears. Setting Loc=808 and then press  can access System Parameter Table.

2.3.2 Set Value Setting

In basal display status, if the parameter lock "Loc" isn't locked, we can set setpoint (SV) by pressing  first, then can press ,  or  to adjust value. Press  key to decrease the value,  key to increase the value, and  key to move to the digit expected to modify. Keep pressing  or , the speed of decreasing or inscreasing value get quick. The range of setpoint is between the parameter SPL and SPH. The default range is 0~400.

● Program segment setting:

Press the  key once and release in the display status, the instrument will be in the setup program status. The set point of the current program StEP will be displayed.

Pressing ,  or  can modify the value.

Pressing  can go to next parameter. The program parameters will be displayed in the sequence of setpoint1, time1, setpoint2, time2.

Pressing and holding  for about 2 seconds will return to the previous parameter. Program step can modify anytime even the program still in running.

Run / Hold only (for AI-518P)

In basic display status, if the program is in stoP status ("StoP" is alternately displayed on the lower window), press and hold the  key for about 2 seconds until the lower display window displays the "Run" symbol, the instrument then will start the program.

If parameter "PAF" set F=1, user can hold the  key for about 2 seconds, instrument will changes to hold status and lower display window displays the "HoLd" symbol. If parameter "PAF" set F=0, "Hold" status only can activate by parameter setting (Srun).



At Hold status, the program is still executing, and the process value is controlled same as setpoint, but the timer stop working, and the running time and setpoint remains. At Hold status, press and hold the  key for about 2 seconds until the lower display window displays the "Run" symbol, the instrument will back to run program



Stop

Press and hold the  key for about 2 seconds in the basic display status, until the lower display window displays the "stoP" symbol, means the stoP operation is executed now, when program stopped, timer will be reset and stop. This operation forces the instrument to stop running, meanwhile, the StEP number will reset to 1, and control output is also stopped

2.3.3 Auto Tuning

When AI control method is chosen (Ctrl=APId / nPid), the PID parameters can be obtained by running auto-tuning.

In basal display status, press  for 2 seconds, the "At" parameter will appear. Press  to change the value of "At" from "oFF" to "on", then press  to active the auto-tuning process. During auto tuning, the instrument executes on-off control. After 2-3 times of on-off action, the instrument will obtain the optimal control parameter value.

If you want to escape from auto tuning status, press and hold the  key for about 2 seconds until the "At" parameter appear again. Change "At" from "on" to "oFF", press  to confirm, then the auto tuning process will be cancelled. (P.S. If parameter "SPr" activate and the heating was running, then will stop the "At" until completed the heat up process.) If the controller was applied on heat/cooling duel output system, PID parameter need separate two group to process auto tuning. When the controller was cooling control from AUX, this time can enable auto tuning to obtain P2, I2, d2.

Note 1: At AI-518P, when auto tuning was running, the program timer will stop until tuning finish.

Note 2: If the setpoint is different, the parameters obtained from auto-tuning are possible different. So you'd better set setpoint to an often-used value or middle value first, and then start auto-tuning. For the ovens with good heat preservation, the setpoint can be set at the highest applicable temperature. Depending on the system, the auto-tuning time can be from several seconds to several hours.

Note 3: Parameter CHYS (on-off differential, control hysteresis) has influence on the accuracy of auto-tuning. Generally, smaller value of CHYS, will get higher precision of auto tuning result. Too large value of CHYS, will made the controller out of control, so, CHYS is recommended to be 2.0.

Note 4: AI series instrument has the function of self-adaptation. It is able to learn the process while working. The control effect at the first run after auto tuning is probably not perfect, but excellent control result will be obtained after a period of time because of self-adaptation.

3. PARAMETERS AND SETTINGS

3.1 Parameter Lock (Loc) and Field Parameters

Parameter was protected by LOC (Parameter LOCK) to prevent setting error. The function was shown as below:

√ : allow to modify data or execute

X : not allow to modify data or execute

Run, Stop, Hold, and Program Time & Temp. function just for AI-518P only

Loc	SV	AT	Primary Parameter	Secondary Parameter	Can changing status to Run, Stop or Hold	Program Step Time & Temp.
0	√	√	√	X	√	√
1	√	X	√	X	X	√
2	X	X	√	X	√	X
3	X	X	√	X	X	X
4~255	X	X	X	X	X	X
808	√	√	√	√	√	√

Loc 808 is the master password, this valve can be change by parameter PASd. **Please set PASd cautiously, if the password lost, you can't access the parameter table again.**

1 to 8 field parameters can be defined by parameters EP1 to EP8. If the number of the field parameters is less than 8, the first idle EP parameter should be set to "nonE". The initial values of EPs and Loc are EP1=HIAL, EP2=LoAL, EP3=HdAL, EP4=LdAL, EP5=nonE, EP6=nonE, EP7=nonE, EP8=nonE and Loc=0.

You can redefine field parameters and Loc to change operation style. For example, you can execute auto tuning from field parameter instead of by pressing \odot in basic display status, and only take HIAL and HdAL as field parameter.

The EP paramters and Loc should be set as follows: EP1=HIAL, EP2=HdAL, EP3=At, EP4=nonE, Loc=1

3.2 The Parameter Table

The parameters can be divided to 8 groups including alarm, control, input, output, communication, system, setpoint and field parameter definition. They are listed as below in sequence:

Code	Name	Description	Setting Range																																			
HIAL	High limit alarm	Alarm on when PV>HIAL Alarm off when PV<HIAL-AHYS, When the value set to Max. will disable this function Alarm output action can be defined by parameter AOP.	-9990~ +32000 units																																			
LoAL	Low limit alarm	Alarm on when PV<LoAL; Alarm off when PV>LoAL+AHYS When the value set to Min. will disable this function																																				
HdAL	Deviation high alarm	Alarm on when PV-SV>HdAL; Alarm off when PV-SV<HdAL-AHYS When the value set to Max. will disable this function																																				
LdAL	Deviation low alarm	Alarm on when PV-SV<LdAL; Alarm off when PV-SV>LdAL+AHYS When the value set to Min. will disable this function HdAL and LdAL can also be used as high limit and low limit alarms when needed. (Refer to the description of parameter AF)																																				
AHYS	Alarm hysteresis	Avoid frequent alarm on-off action because of the fluctuation of PV	0~2000 units																																			
AdIS	Alarm display	oFF : Will not display alarm message in the lower display window when alarming; on : Alternately display alarm message in the lower display window when alarming.	oFF / on																																			
AOP	Alarm output allocation	<table border="1"> <thead> <tr> <th>Alarm</th> <th>LdAL (x 1000)</th> <th>HdAL (x100)</th> <th>LoAL (x10)</th> <th>HIAL (x1)</th> </tr> </thead> <tbody> <tr> <td>Output to</td> <td></td> <td></td> <td></td> <td></td> </tr> <tr> <td>None</td> <td>0</td> <td>0</td> <td>0</td> <td>0</td> </tr> <tr> <td>AL1</td> <td>1</td> <td>1</td> <td>1</td> <td>1</td> </tr> <tr> <td>AL2</td> <td>2</td> <td>2</td> <td>2</td> <td>2</td> </tr> <tr> <td>AU1</td> <td>3</td> <td>3</td> <td>3</td> <td>3</td> </tr> <tr> <td>AU2</td> <td>4</td> <td>4</td> <td>4</td> <td>4</td> </tr> </tbody> </table> <p>Example: $AOP = \frac{3}{LdAL} \quad \frac{3}{HdAL} \quad \frac{0}{LoAL} \quad \frac{1}{HIAL}$ It shows that HdAL and LdAL are sent to AU1, LoAL has no output, HIAL is sent to AL1. Note 1: When AUX is used as auxiliary output in bidirectional (heating/refrigerating) control, alarm to AU1 and Au2 won't work. Note 2: Installing L5 dual relay output module in ALM or AUX can implement AL2 or AU2 alarm.</p>	Alarm	LdAL (x 1000)	HdAL (x100)	LoAL (x10)	HIAL (x1)	Output to					None	0	0	0	0	AL1	1	1	1	1	AL2	2	2	2	2	AU1	3	3	3	3	AU2	4	4	4	4	0~4444
Alarm	LdAL (x 1000)	HdAL (x100)	LoAL (x10)	HIAL (x1)																																		
Output to																																						
None	0	0	0	0																																		
AL1	1	1	1	1																																		
AL2	2	2	2	2																																		
AU1	3	3	3	3																																		
AU2	4	4	4	4																																		

Ctrl	Control mode	<p>onoF: on-off control. For situation not requiring high precision</p> <p>APId: advanced artificial intelligence PID control. (Recommended)</p> <p>nPid: standard PID algorithm with anti integral-saturation function (no integral when PV-SV > proportional band)</p> <p>POP: Transmit PV. The instrument works as a temperature re-transmitter.</p> <p>SOP: Transmit SV. The instrument works program generator.</p>	<p>onoF</p> <p>APId</p> <p>nPid</p> <p>POP</p> <p>SOP</p>
Srun	Running Status	<p>run: Control or program was running, "RUN" led light on</p> <p>StoP : Control or program was stopped. Lower display keep flashing "StoP" and "RUN" led light off.</p> <p>HoLd: This only functioned on AI-518P, this will keeping temperature when this HoLd was appeared. If the parameter Pno=0(Non timing limitation mode), controller will functioning same at AI-518, if Pno>0 (in program mode),and Srun was set as "HoLd", means the timer stops and the temperature remains; user can resume the timer by pressing the "Hold" from panel.</p>	<p>StoP /</p> <p>run /</p> <p>HoLd</p>
Act	Acting method	<p>rE: Reverse acting. Increase in measured variable causes a decrease in the output, such as heating control.</p> <p>dr: Direct acting. Increase in measured variable causes an increase in the output, such as refrigerating control.</p> <p>rEbA: Reverse acting with low limit alarm and deviation low alarm blocking at the beginning of power on.</p> <p>drbA: Direct acting with high limit alarm and deviation high alarm blocking at the beginning of power on.</p>	<p>rE</p> <p>dr</p> <p>rEbA</p> <p>drbA</p>
At	Auto tuning	<p>oFF: Auto tuning function was off.</p> <p>on: Active auto turning function to calculate the values</p> <p>FoFF : Auto tuning function was off, cannot activate again by pressing key from panel .</p>	<p>oFF / On /</p> <p>FoFF</p>
P	Proportional band	<p>Proportional band in PID and APID control. Instead of percentage of the measurement range, the unit is the same as PV.</p> <p>Generally, optimal P, I, D and Ctl can obtained by auto tuning. They can also be manually inputted if you already know the correct values.</p>	<p>1~32000</p> <p>units</p>
I	Time of Integral	No integral effect when I=0	<p>0~9999</p> <p>seconds</p>
d	Time of Derivative	No derivative effect when d=0	<p>0~999.9</p> <p>seconds</p>
Ctl	Control period	<p>Small value can improve control accuracy.</p> <p>For SSR, thyristor or linear current output, it is generally 0.5 to 3 seconds.</p> <p>For Relay output or in a heating/refrigerating dual output control system, generally 15 to 40 seconds, because small value will cause the frequent on-off action of mechanical switch or frequent heating/refrigerating switch, and shorten its service life. Ctl is recommended to be 1/5 – 1/10 of derivative time. (It should be integer times of 0.5 second.)</p> <p>When the parameter OPt or Aut = rELy, Ctl will be limited to more than 3 seconds. Auto tuning will automatically set Ctl to suitable value considering both control precision and mechanical switch longevity.</p> <p>When the parameter Ctrl = onoF, Ctl will used as timer to make delay time to avoid the power restart in short period. It suit for compressor protection.</p>	<p>0.2~</p> <p>300.0</p> <p>Sec</p>
P2	2 nd Proportional band	<p>The 2nd proportional band in PID and APID control. Instead of percentage of the measurement range, the unit is the same as PV.</p> <p>Generally, optimal P, I, D and Ctl can obtained by auto tuning. They can also be manually inputted if you already know the correct values.</p>	<p>1~32000</p> <p>units</p>
I2	2 nd Time of Integral	No integral effect when I=0	<p>0~9999</p> <p>seconds</p>
d2	2 nd Time of Derivative	No derivative effect when d=0	<p>0~999.9</p> <p>seconds</p>
Ctl2	2 nd Control period	Same description and function as parameter as "Ctl"	<p>0.2~</p> <p>300.0</p> <p>Sec</p>
CHYS	Control Hysteresis	<p>CHYS is used for on-off control to avoid frequent on-off action of relay.</p> <p>For a reverse acting (heating) system, when PV > SV, output turns off; when PV<SV-CHYS, output turns on.</p> <p>For a direct acting (cooling) system, when PV<SV, output turns off; when PV>SV+CHYS, output turns on.</p>	<p>0~2000</p>

InP	Input specification Code	InP	Input spec.	InP	Input spec.	0~37
		0	K	20	Cu50	
1	S	21	Pt100			
2	R	22	Pt100 (-80~+300.00°C) *			
3	T	25	0~75mV voltage input			
4	E	26	0~80ohm resistor input			
5	J	27	0~400ohm resistor input			
6	B *	28	0~20mV voltage input			
7	N	29	0~100mV voltage input			
8	WRe3-WRe25	30	0~60mV voltage input			
9	WRe3-Wre26	31	0~500mV voltage input			
10	Extended input specification	32	100~500mV voltage input			
12	F2 radiation type pyromter	33	1~5V voltage input			
15	4 ~ 20mA (installed I4 module in MIO)	34	0~5V voltage input			
16	0 ~ 20mA (installed I4 module in MIO)	35	0~10V			
17	K (0~300.00°C) *	36	2~10V			
18	J (0~300.00°C) *	37	0~20V			
dPt	Display Resolution	Four formats (0, 0.0, 0.00, 0.000) are selectable Note 1: For thermocouples or RTD input, only 0 or 0.0 is selectable, and the internal resolution is 0.1. When S type thermocouple is used, dPt is recommended to be 0. If Inp= 17,18 or 22, resolution will support display 0.0 or 0.00				0 / 0.0 / 0.00 / 0.000
ScL	Signal scale low limit	Define scale low limit of input. It is also the low limit of transmitter output (Ctrl=POP or SOP) and light bar display.				-9990~+32000 units
ScH	Signal scale high limit	Define scale high limit of input. It is also the high limit of retransmission output (Ctrl=POP or SOP) and light bar display.				-1999~+4000 units
Scb	Input Shift Adjustment	Scb is used to shift input to compensate the error caused by transducer, input signal, or auto cold junction compensation of thermocouple. PV after compensation=PV before compensation + Scb It is generally set to 0. The incorrect setting will cause measurement inaccurate.				0~40
FILt	PV input filter	The value of FILt will determine the ability of filtering noise. When a large value is set, the measurement input is stabilized but the response speed is slow. Generally, it can be set to 1 to 3. If great interference exists, then you can increase parameter "FILt" gradually to make momentary fluctuation of measured value less than 2 to 5. When the instrument is being metrological verified, "FILt" s can be set to 0 or 1 to shorten the response time.				50C, 50F, 60C, 60F
Fru	Selection of power frequency and temperature scale	50C: 50Hz,display °C. , 50F: 50Hz, display °F 60C: 60Hz,display °C. , 60F: 60Hz, display °F. Input has max. anti-interference ability to 50Hz or 60Hz frequency when parameter set;				SSr rELy 0-20 4-20 PHA
OPt	Main output type	SSr: Output SSr drive voltage or thyristor zero crossing trigger signal. G, K1 or K3 module should be installed. The output power can be adjusted by the on-off time proportion. The period (Ctl) is generally 0.5~4 seconds. rELy: for relay contact output or for execution system with mechanical contact switch. To protect the mechanical switch, the output period (Ctl) is limited to 3~120 seconds, and generally is 1/5 to 1/10 of derivative time. 0-20: 0~20mA linear current output. X3 or X5 module should be installed in OUTP slot.				4-20: 4~20mA linear current output. X3 or X5 module should be installed in OUTP slot. PHA: Single-phase phase-shift output. K5 module should be installed in OUTP slot. PHA is only for 50Hz power supply, and don't support bidirectional control system.
Aut	Auxiliary output type	Define AUX only when AUX is worked as the auxiliary output of a heating/refrigerating bidirectional system. SSr: to output SSr driver voltage or thyristor zero crossing trigger signal. G or K1 module should be installed. The output power can be adjusted by adjusting the on-off time proportion. The period (Ctl) is generally 0.5~4 seconds. rELy: for relay contact output or for execution system with mechanical contact switch. To protect the mechanical switch, the output period (Ctl) is limited to 3~120 seconds, and generally is 1/5 to 1/10 of derivative time. 0-20: 0~20mA linear current output. X3 or X5 module should be installed in AUX slot. 4-20: 4~20mA linear current output. X3 or X5 module should be installed in AUX slot. Note: In a heating/refrigerating bidirectional control system, if any of OPt or Aut is set to rELy, then Ctl is limited to 3~120.				SSr rELy 0-20 4-20

OPL	Output low limit	0~100%: OPL is the minimum output of OUP in single directional control system. -1~-110%: The instrument works for a bidirectional system, and has heating/refrigerating dual output. When ACt=rE or rEbA, OUP (main output) works for heating, and AUX (Auxiliary output) works for refrigerating. When Act=dr or drbA, OUP works for refrigerating, and AUX works for heating. In a bidirectional system, OPL for define the limitation of maximum cooling output. So, when the OPL= -100%, means no limitation on cooling output. If set OPL=-110%, it can made current output excess 10% on maximum output. When the output type is SSR output or relay output, maximum of cooling output should not set more than 100%	-110~ +110%
OPH	Output upper limit	OPL limits the maximum of OUP (main output) when PV<OEF. OPH should be greater than OPL.	0~110%
OEF	Work range of OPH	When PV<OEF, the upper limit of OUP is OPH; when PV>OEF, the upper limit of OUP is 100%. For example, to avoid that the temperature raises too quickly, under 150℃, a heater can work only under 30% of power, then we can set OEF=150.0 (℃), OPH=30 (%)	-999~ +3200
Addr	Communication address	In the same communication line, different instrument should be set to different address.	0~80
bAud	Baud rate	The range of baud rate is 1200~19200bit/s. When COMM/AUX slot is used as AUX, bAud should be set to 0. For D2 dimension instrument, If set parameter bAud = 2, it can be used for AU1 + AL1 alarm output. It can apply on AI-518P, event output function, because event output only can output by AL1 or AL2 For D2 dimension instrument, if I2 is installed and bAud = 1, then it can input on-off signal to switch SV1 and SV2 (AI-518) or switching the program status RUN/Stop (AI-518P) by connecting a switch between terminals number 3 and 5.	0~19.2K
Et	Event input type	When I2 module was installed, the meter have following functions, nonE : Disable event input function reSt : Run / Stop switching function. Connected in short time, start to running program, keep connect more than 2 sec, program switch to stop. SP1.2 : Switching between setpoint 1 and setpoint 2 when use AI-518 or Pno=0 at AI-518P. MIO in open status, SV=SP1, when MIO in close status, SV=SP2 Pld2 : Switching 1 st PID and 2 nd PID. When use as single direction control, MIO in open status, P, I, d and Ctl was active, when MIO in close status, P2, I2, d2 and Ctl2 was active	nonE / rest / SP1.2 / Pld2
AF	Advanced function	AF is used to select advanced function. The value of AF is calculated as below: AF=Ax1 + Bx2 + Cx4 + Dx8 + Ex16 + Fx32 + Gx64 A=0, HdAL and LdAL work as deviation high and low limit alarms; A=1, HdAL and LdAL work as high and low limit alarms, and the instrument can have two groups of high and low limit alarms. B=0, Alarm and control hysteresis work as unilateral hysteresis; B=1, As bilateral hysteresis. C=0, The light bar indicates the output value; C=1, The light bar indicates the process value (for instruments with light bar only). D=0, Loc=808 can access the whole parameter table; D=1, Loc=PASd can access the parameter table. E=0, Normal application on HIAL and LoAL; E=1, HIAL AND LoAL will become to deviation high alarm and Deviation low alarm F=0, Fine control mode, internal control resolution was demonstration's 10 times. When on linear input mode, biggest display value is 3200 units F=1, Wide range display mode, when the value is bigger than 3200 ,chooses this option	0~255
		G=0, When the thermocouple or RTD input is burnt out, PV value will increase and trigger the high limit alarm. G=1, When the thermocouple or RTD input is burnt out, PV value will increase and NOT trigger the high limit alarm. After it was sets, High Limit alarm will have 30 sec. delay for trigger in normal usage. Note: AF=0 is recommended.	
PASd	Password	When PASd=0~255 or AF.D=0, set Loc=808 can enter the whole parameter table. When PASd=256 ~ 9999 and AF.D=1, only Loc=PASd can access the whole parameter table. Please setting PASd cautiously, if the password is lost, you can't access the parameter table again.	0~9999
SPL	Low limit of SV	Minimum value that SV is allowed to be.	-999~
SPH	Upper limit of SV	Maximum value that SV is allowed to be.	+3000 unit
SP1	Setpoint 1	When Pno=0 or 1, then SV=SP1	SPL~ SPH
SP2	Setpoint 2	When I2 module installed in MIO slot, SP1 and SP2 can be switched by an external switch. If the switch is off, SV=SP1; if the switch is on, SV=SP2.	

SPr	Ramp Slope limit (Only for AI-518P)	Once SPr was set, if PV<SV when program start, the first step of ramp slope will limited by SPr value until the temperature reach the first SV , under this limitation, the RUN lamp will keep flashing. For Ramp mode. SPr had effect on first step only. For Soak mode, SPr had effect on each step.	0~3200°C Min
Pno	No. of Program step (Only for AI-518P)	To define the number of program in use. Pno= 0 , disable the program running mode, then AI-518P will same as AI-518, meanwhile, can set the parameter "SPr" to limit the ramp time. Pno=1~30 , AI-518P working as normal programmable controller	0~30
PonP	Program run mode after power restart (Only for AI-518P)	Cont : Continue to run the program from the original break point. If STOP STATUS was activated before power cut, then it (the program) will keep stop status after power restart. StoP : Stop the program after power restart run1 : Start to run the program from step 1 unless the instrument was in "stop" state before power cut. dAst : If these have deviation alarm after power resume, then stop the program, otherwise, continue run the program from the original break point. HoLd : Go into HOLD state after power on. If it is in StoP state before power cut, then keep in StoP State after power on.	Cont / StoP / run1 / dAst / HoLd
PAF	Program Running mode (Only for AI-518P)	PAF = Ax1 + Bx2 + Cx4 + Dx8 + Ex16 + Fx32 When A=0, Enable ready (rdy) function A=1, Disenable ready (rdy) function B=0, Ramp mode. B=1, Soak mode, C=0, Time unit in Minute, the range is 0.1~3200. C=1, Time unit in Hour, the range is 0.1~3200 D=0, Disable PV start up function. D=1, Enable PV start up function. E=0, When work as program generator, upper windows display PV. E=1, When work as program generator, upper windows display the current step F=0, Standard operate mode on Hold and Run switching. F=1, Hold and Run switching can operate on panel Please refer to Page 48 for more detail of Ramp mode, Soak mode and PV start up function.	
EP1~ EP8	Field parameter definition	Define 0~8 of the parameters as field parameters.	nonE and all parameter codes

3.3 Additional Remarks of Special Functions

3.3.1 Single-phase phase-shift trigger output

When OPt is set to PHA, installing a K5 or K6 module in OUPt slot can single-phase phase-shift trigger a TRIAC or 2 inverse parallel SCRs. It can continuously adjust heating power by control the conduction angle of thyristor. With non-linear power adjustment according to the characters of sine wave, it can get ideal control. The trigger adopts self-synchronizing technology, so it can also work even when the power supplies of the instrument and the heater are different. Phase-shift trigger has high interference to the electric power, so user should pay attention to the anti-interference ability of other machines in the system. Now the K5 or K6 module can be only used in 50Hz power supply.

3.3.2 Alarm blocking at the beginning of power on

Sometimes the fault alarm may occur at the beginning of power on. In a heating system, at the beginning of power on, its temperature is much lower than the set point. If low limit and deviation low limit are set and the alarm conditions are satisfied, the instrument should alarm, but there is no problem in the system. Contrarily, in an refrigerating system, the unnecessary high limit or deviation high limit alarm may occur at the beginning of power on. Therefore, AI instruments offer the function of alarm blocking at the beginning of power on. When Act is set to rEbA or drbA, the corresponding low or high alarms are blocked until the alarm condition first clears. If the alarm condition is satisfied again, the alarm will work.

3.3.3 Setpoints switch

If an I2 module is installed in MIO slot (or bAud=1 and I2 installed in COMM slot). User can connect external on off switch to realize some control function. Set Et = rest, can switching program run and stop. For AI-518, or AI518P when its Pno=0, set Et = SP1.2, can switching between setpoint 1 and setpoint 2.

3.3.4 Communication function

S or S4 module can be installed at COMM slot to communicate with a computer. The instrument can be controlled by computer. AI instruments can be connected to the computer through RS232 or USB communication port. Every communication port of a computer can connect up to 60 AI instruments, or 80 AI instruments if a repeater is installed. A computer with 2 communication ports can connect up to 160 instruments. Please note that every instrument connecting to the same communication line should be set to a unique communication address. If the number of instrument are enough, 2 or more computers can be used and a local network can be set up.

AIDCS application software, a distributed control system software developed by Yudian, can control and manage 1~160 AI instruments, record the data, generate and print reports. If users want to develop their own distributed control system by themselves, the communication protocol of AI instruments can be free offered. There are many famous distributed control system software support AI instruments.

3.3.5 Temperature re-transmitter / Program generator / Manual current output

Besides AI PID, stand PID control and on-off control, if the output is defined as current output, the instrument can also retransmit PV (process value) or SV (setpoint) into linear current and output from OUP. The precision of current output is 0.2%FS. Base on that ability, AI-518 can become temperature re-transmitter and AI-518P can become program generator

The corresponding parameters are set as below:

When Ctrl=POP, PV is retransmitted to linear current, the instrument works as temperature re-transmitter.

When Ctrl=SOP, SV is transmitted and outputted, and the instrument works as manual current output controller(AI-518) or program generator(AI-518).

OPt is used to choose output type, generally 4~20mA or 0~20mA output.

Parameter InP, SCL, SCH, and Scb are used for selecting input specification, setting low limit or high limit of PV and adjusting input.

For example, in order to retransmit temperature read from K thermocouple, range 0~400°C, to current 4~20mA, the parameters are set as below: InP=0, ScL=0.0, ScH=400.0, OPt=4~20, and X3 or X5 linear current module is installed in OUP slot. When the temperature is less than or equal to 0°C, the output is 4mA. When the temperature equals to 400°C, the output is 20mA.

4. Further description for the operation of AI-518P series instrument

AI-518P v8.0 program type temperature controller is used in the application where the setpoint should be changed automatically with the time. It provides 30 segments program control which can be set in any slope and the function of jump, run, hold and stop can also be set in the program. Measurement startup function, preparation function and power-cut/power-resume event handling modes also provided.

4.1 Concepts and functions Program

StEP:

The No. of the program Step can be defined from 1 to 30, and the current Step is the program Step being executing.

StEP time:

Total run time of the program step. The unit is minute and the available value range from 1 to 9999.

Running time:

The Time of current Step has run. As the running time reaches the Step time, the program will jump to the next Step automatically.

Jump:

The program can jump to any other steps in the range of 1 to 30 automatically as you programmed in the program Step, and realize cycle control.

Run/Hold:

When program is in the running status, timer works, and set point value changes according to the preset curve. When program is in the holding status, timer stops, and set point remains to make temperature hold also. The holding operation can be programmed into the program step.

Stop:

When the stop operation is activated, the program will stop, running time will be clear, event output switch will reset and the output control will stop output. If run operation is activated when instrument is in the stop status, the program will start-up and run again from the set step no. The stop function can be programmed into the program Step. The stop operation can also be performed manually at any time. (After stop operation is done, the step no. will be set to 1, but user can modify it again). If the program ran the last step of "Pno", program will stop automatically.

Power cut/resume event handling:

There are 5 events handling method selectable for power resume after power cut off. Please refer to parameter PonP.

PV startup and PV preparation function (rdy function) :

At the beginning of starting a program, resuming a program after power cut or continuing to run a program after it is just modified, the PV (process value) are often quite different from the set point. PV startup function and PV preparation function can make PV and set point consistent, and avoid unexpected result. When PV startup function enabled, the instrument will adjust the running time automatically to make the expected set point is the same as the current PV.

For example, the program is set that the temperature will be raised from 25°C to 625°C in 600 minutes. But the current PV is 100°C, then the instrument will automatically to run this program start from 75 minutes, that mean changed the temperature raised from 100°C to 625°C in 525 minutes (600-75) min.

At the above situation(PV=100, SV=25, first step SV), when PV preparation function is enable, the alarm function will be blocked at that time, and PV will be adjusted to approach SV until the deviation alarm condition is released (PV is between SV-LdAL and SV+HdAL). After deviation alarm was off, the controller starts to run the program again. Preparation function (rdy Function) is helpful to keep the integrity of the program, but it will prolong the program time because the start of the program is postponed.

PV startup function is prior to PV preparation function. If both function are enabled, the system apply PV startup first, if PV startup function works, PV preparation function will not be activated.

Curve fitting:

Curve fitting is adopted as a kind of control technology for AI-518P series instrument. As controlled process often has lag time in system response, by the way of curve fitting the instrument will smooth the turning point of the linear

heating-up, cooling-down and constant temperature curves automatically. The degree of the smooth is relevant with the system's lag time $t(t=d+Ct)$; the longer of the lag time, the curve will more smooth. On the opposite the smooth function will be weaker. Generally the shorter of the process lag time (such as temperature inertia), the better of the program control on effect. By the way of the curve fitting to deal with the program curves, will avoid overshoot. Note: The characteristic of the curve fitting will force the program control to generate fixed negative deviation during the linear heating-up and fixed positive deviation during the linear cooling-down, the deviation is direct proportional to the lag time and the speed of heating-up (cooling-down). This phenomenon is normal.

5. Programming and operation (For AI-518P only)

5.1 Ramp Mode(PAF : B=0)

Programming of instrument has uniform format of temperature-time-temperature, which means temperature "A"(SP 1), passed Time "A"(t01), then reached Temperature "B"(SP 2). The unit of temperature set is °C and the unit of time set is minute. The following example includes 5 steps, which is linear temperature heating up, constant temperature, linear temperature cooling down, jump cycling, ready, Hold..

StEP1: SP 1=100 , t 1=30.0 Start linear temperature heating up from 100°C, and the time needed 30 minutes to reach SP 2(400 degree).

StEP2: SP 2=400 , t 2=60.0 Temperature raised to 400°C, slope of raising curve is 10°C/minute, The program take 60 minutes to raise temperature to SP3 (400 degree). It means keep the same temperature in 60 minutes.

StEP3: SP 3=400 , t 3=120.0 This is the step for temperature cooling down, slope of cooling curve is 2°C/minute, and the time needed is 120 minutes to reach SP4 (160degree).

StEP4: SP 4=160 , t 4=0.0 When temperature reached 160 degree, the program get in Hold state. If need go to next step, it needed operator to executed the "run" for next step.

StEP5: SP 5=160 , t05=-1.0 Jump to StEP1 to start from beginning.

In this example, it is assumed that the deviation high alarm is set to 5°C. Because the temperature of StEP 5 is 160°C, and the temperature of StEP1 is 100°C, when program jumps from StEP 5 to StEP 1, the program will change to preparation state at first(if preparation mode "rdy" was enabled), i.e., Control the temperature until the deviation between setpoint and PV is less than deviation high alarm value. After temperature is controlled to 105°C, the program will be started from StEP 1, and run the above steps again. The temperature control drawing was shown below.

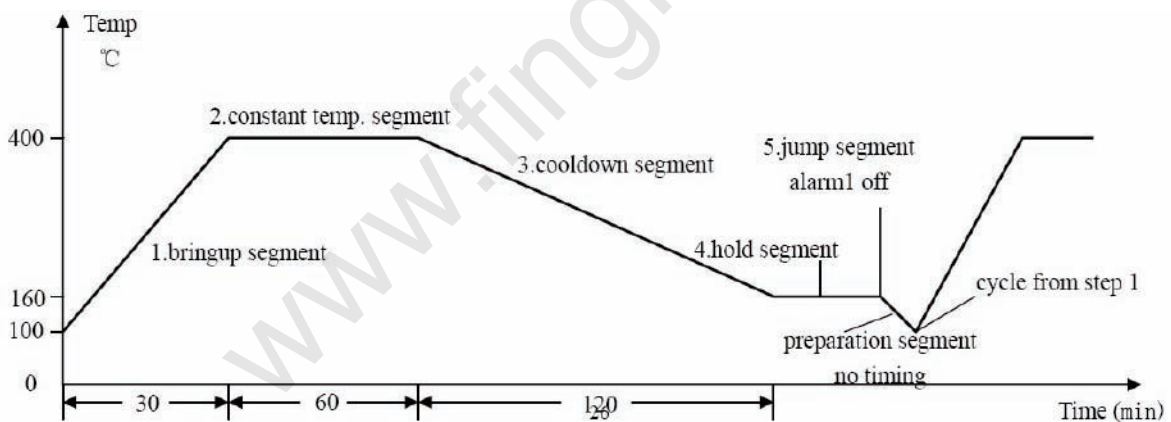

5.2 Soak mode(PAF : B=1)

Suitable for the process which does not need to establish the temperature slope, can simplify the programming and more effective. Each step also can set parameter "SPr" to define temperature raise slope, if "SPr=0" raising speed will set to maximum. Because cannot know the actual time which spend on temperature raising, user can enable "rdy" function to ensure the correct soak time.

Time setting

Set "t-xx" = 0.1~3200 (min)

Set the time of xx StEP. (Time units can be change to Hour by parameter "PAF".)

Set "t-xx" = 0.0

The program hold on StEP xx, program will hold running and hold counting time.

Set "t-xx" = -121.0

The program stops, and switches to stop status.

Set "t-xx" = -0.1~-122.0

Negative value of this range represents a jump operation which will jump to step xx and event output. Range -1~-120 is for step jumping application. The step jumping cannot greater than "Pno"(No. of Program step).

Decimal point use for control the event output from AL1 and AL2. (Modular), Note, if parameter AOP was assigned alarm action will trigger from AL1 and AL2, the event output also will cause alarm from AL1 and AL2.

When set

-XXX.1, AL1 activate, AL2 release

-XXX.2, AL1 release, AL2 activate

-XXX.3, AL1 and AL2 activate

-XXX.4, AL1 and AL2 release

Example:

Example 1 : t -5 = -1.1 ; means when the program arrived step 5, AL1 activate, AL2 release and will jump to step 1 continues running

Example 2 : t-6 = -0.3 ; means when the program arrived step 6, AL1 and AL2 activate and continuous next step.

Note: The program will be held if it jump from a control segment to another control segment (an Hold action will be inserted between two control sections), external run/Hold operation is needed to release the Hold status. It is not allowed that the jump section jump to itself (for example: t -6= -6), otherwise, the Hold status cannot be released.

Program arrangement of multi-curve operation

AI-518P has the advanced function of flexible program arrangement. Normally, when the program stops, the StEP will be automatically set to 1. Thus if StEP is not change to other value, a program will start from step 1. If multiple curves are defined, the control can jump to different curve by setting step 1 as jump segment.

For example: There are three curves with the length of 3 steps represent three groups of process parameter, they are

separately arranged on StEP2-StEP4, StEP5-StEP7, StEP8-StEP10. Settings are as follows:

t- 1=-2.0 Execute the program of curve 1 (StEP2-StEP4)

t- 1=-5.0 Execute the program of curve 2 (StEP5-StEP7)

t- 1=-8.0 Execute the program of curve 3 (StEP8-StEP10)

Note: Can choose the curves by setting the value of StEP "t-1" set to -2.0, -5.0 or -8.0 before the program startup.

www.finglai.com